Comfort-Cire® **Century**®

SE Series

Two Stage Multi-Position Gas Furnace 96%

GFM96T080C4S1A

Parts List



MARS®

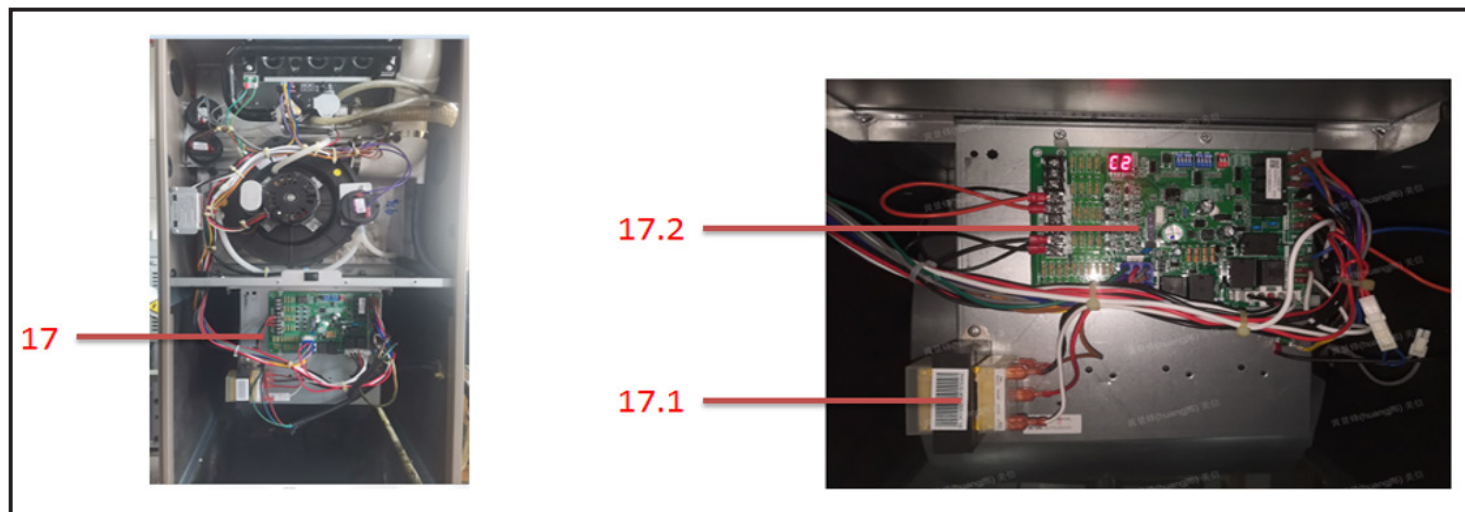
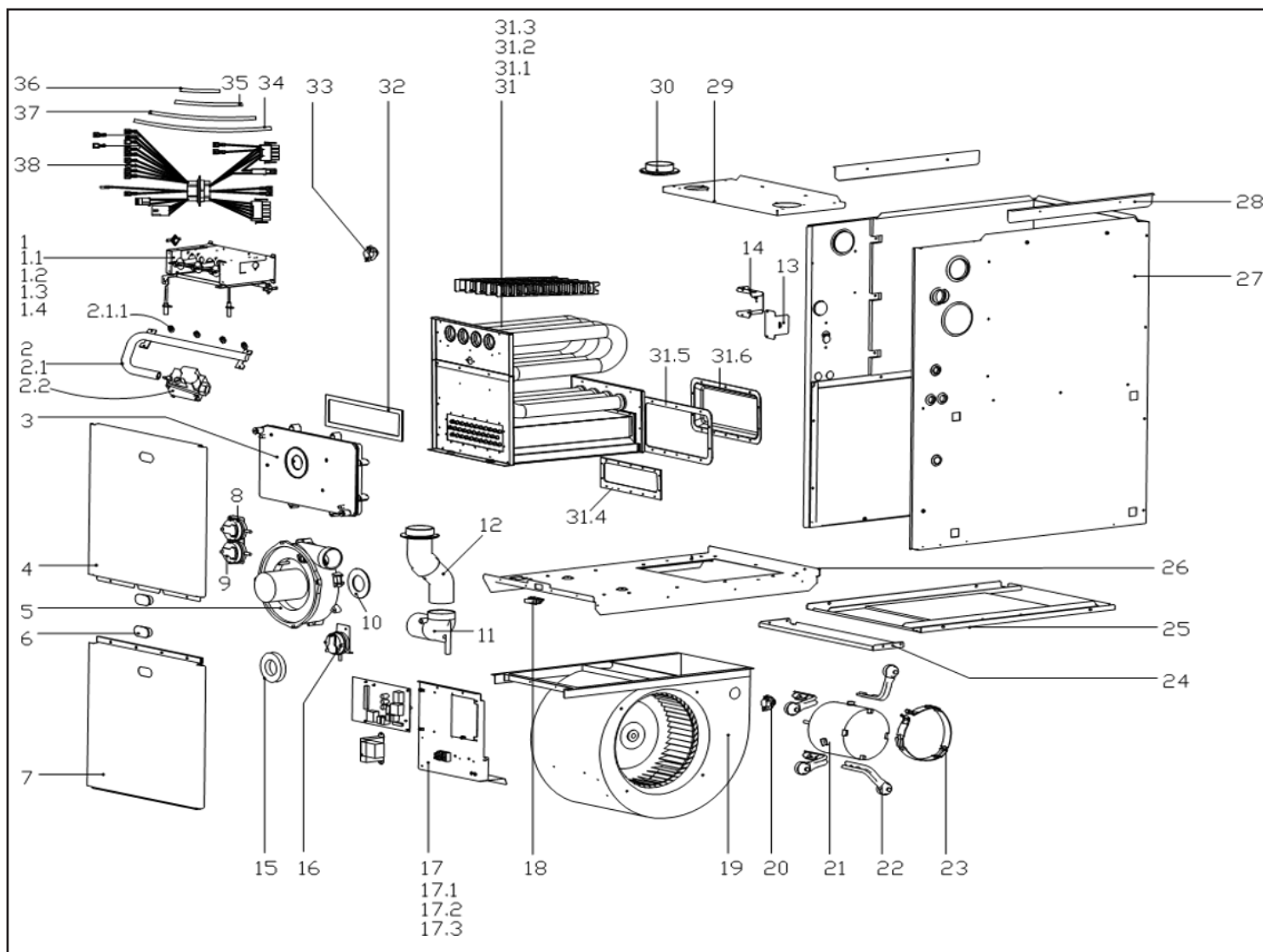

EX_ID	Spare Parts Code	Part Name(EN)	Qty.	Recommend store spare parts
1	12227600001400	Combustor assembly	1	
1.1	17400513000045	Thermostat	2	YES
1.2	17427600000007	Firing pin	1	YES
1.3	11201006000010	Special sensor	1	YES
1.4	17427600000004	Combustor	4	
2	15427600000060	Gas pipe assembly	1	
2.1	15427600000002	Gas pipe assembly	1	
2.1.1	15527600000001	Copper nozzle	4	YES
2.2	17427600001389	Gas Valve	1	YES
3	12127600000019	Drain box weld assembly	1	YES
4	12227600003205	Upper cover assembly	1	
5	17400801002944	Exhaust fan components	1	YES
6	12127600000009	Plastic cover	2	
7	12227600003219	Bottom cover assembly	1	
8	17400515000422	Air switch	1	YES
9	17400515000421	Air switch	1	YES
10	12427600000049	Smoke exhaust fan gasket	1	
11	12127600000015	Smoke exhaust elbow	1	YES
12	12127600000016	Smoke exhaust pipe joint assembly	1	YES
13	12227600000817	Junction box cover	1	
14	12227600000818	Junction box	1	
15	12127600000366	Smoke vent buckle	1	YES
16	17400515000420	Air switch	1	YES
17	17227600000941	E-part box assembly	1	
17.1	11203103000197	Linear Transformer	1	YES
17.2	17127600000708	Tie-in assembly of main control board	1	
18	17427600001148	Door switch	1	YES
20	17400513000874	Thermostat	2	YES
21	11002015011986	Brushless DC Motor	1	YES
22	12223000001933	Motor bracket assembly I	4	
23	12223000001993	Motor bracket II	1	
24	12227600003214	Bottom supporting board	1	
25	12227600000819	Base sealplate assembly	1	
26	12227600000217	Partition board assembly	1	
27	12227600003227	Cabinet assembly	1	
28	12227600000274	Supporting bar assembly	2	
29	12227600003208	Front cover assembly	1	
30	12127600000010	Air inlet pipe joint	1	
31	15727600000075	Heat exchanger assembly	1	
31.1	15727600000010	Primary heat exchanger assembly	1	
31.2	15827600000031	Secondary heat exchanger assembly	1	
31.3	12227600000059	Spoiler	4	
31.4	12427600000023	Heat exchanger gasket	1	
31.5	12427600000031	Gas-collecting cover gasket	1	
31.6	12227600000235	Back gas-collecting cover	1	
32	12427600000033	Drain pan gasket	1	
33	17400513001114	Thermostat	1	YES
34	12627600000005	Silicone tube	1	
35	12627600000006	Silicone tube	2	
36	12627600000007	Silicone tube	1	
37	12627600000009	Silicone tube	1	
38	17401203016840	Strong electric cable group	1	

Due to ongoing product improvements, specifications and dimensions are subject to change and correction without notice or incurring obligations. Determining the application and suitability for use of any product is the responsibility of the installer. Additionally, the installer is responsible for verifying dimensional data on the actual product prior to beginning any installation preparations.

Incentive and rebate programs have precise requirements as to product performance and certification. All products meet applicable regulations in effect on date of manufacture; however, certifications are not necessarily granted for the life of a product. Therefore, it is the responsibility of the applicant to determine whether a specific model qualifies for these incentive/rebate programs.



1900 Wellworth Ave., Jackson, MI 49203 • Ph. 517-787-2100 • www.marsdelivers.com

